

Diagrammes des classes

MD.01-MO-NE

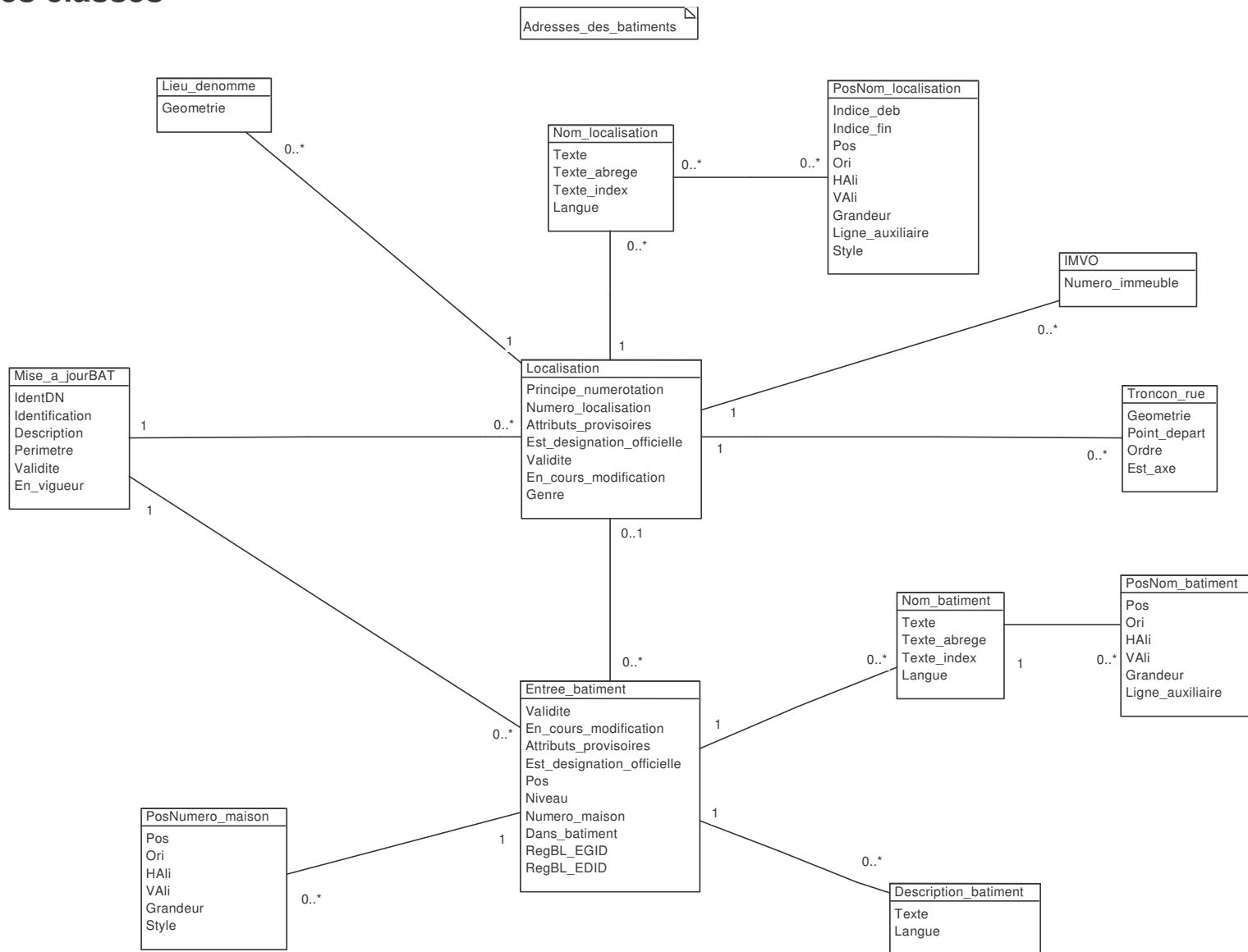

Altimetrie

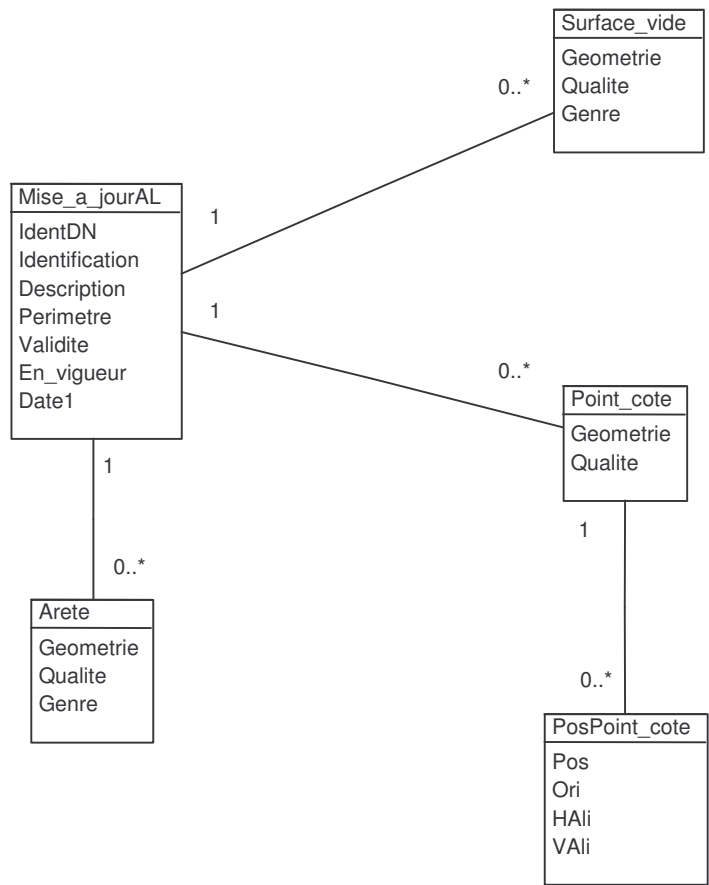

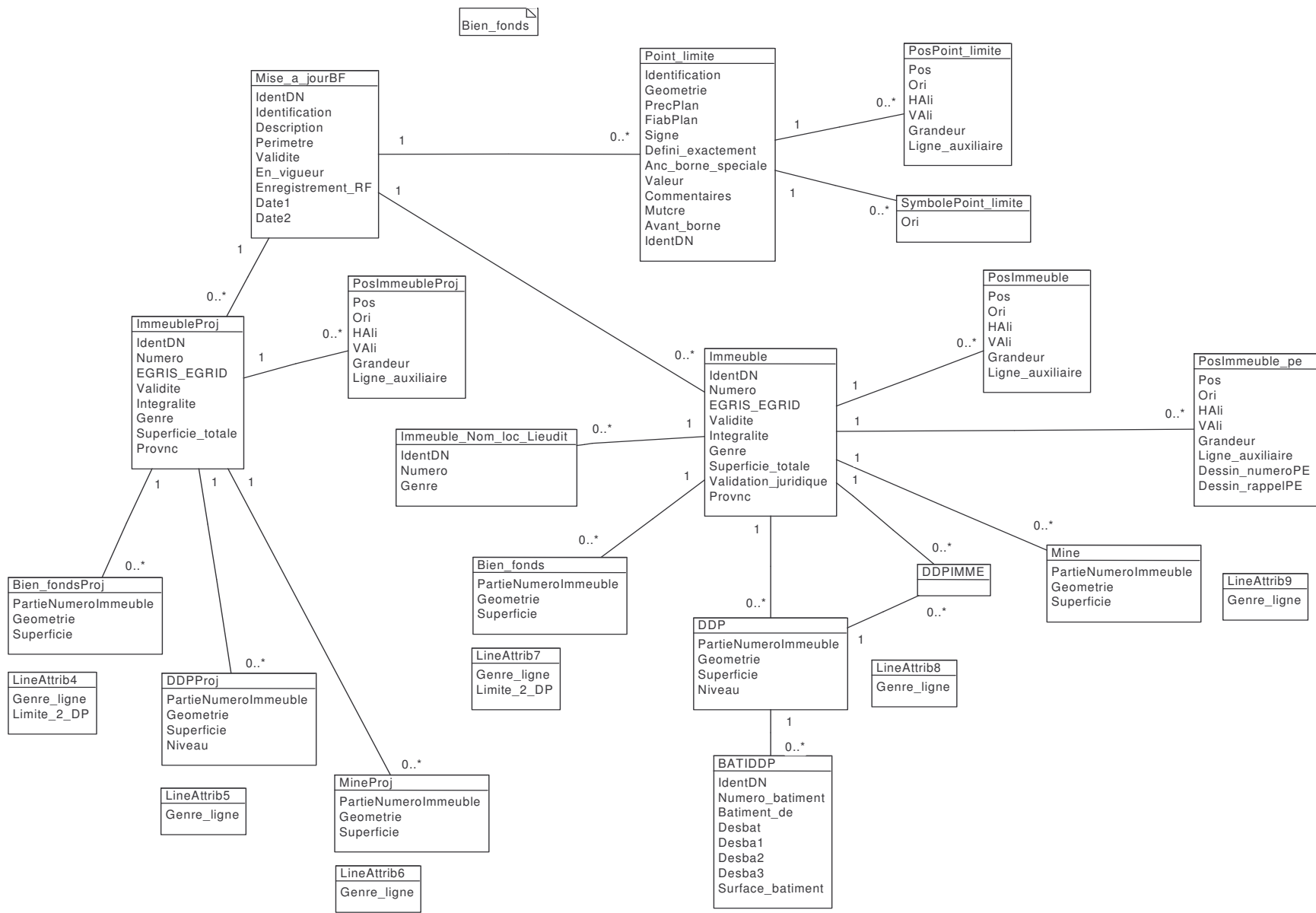

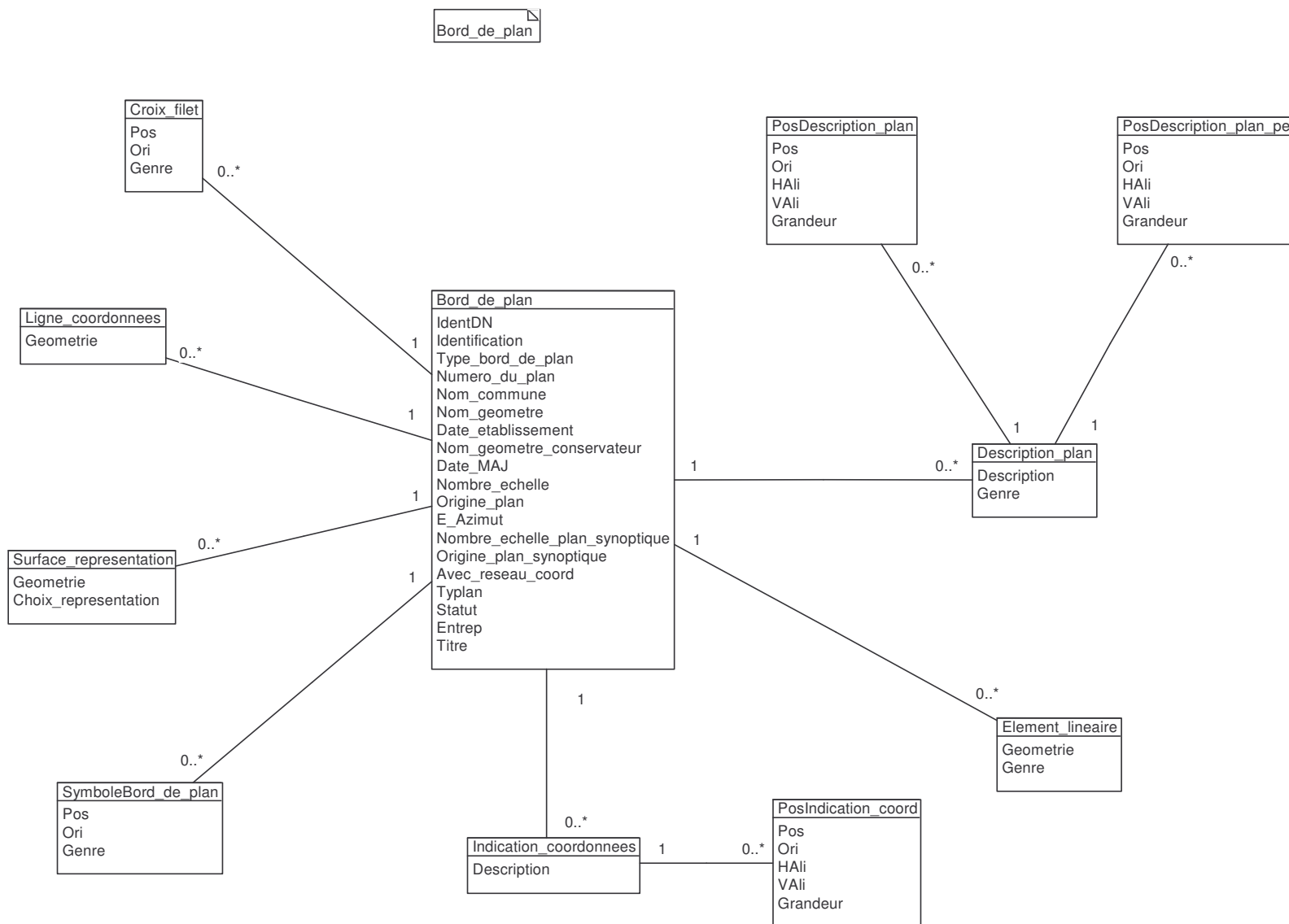

Conduites

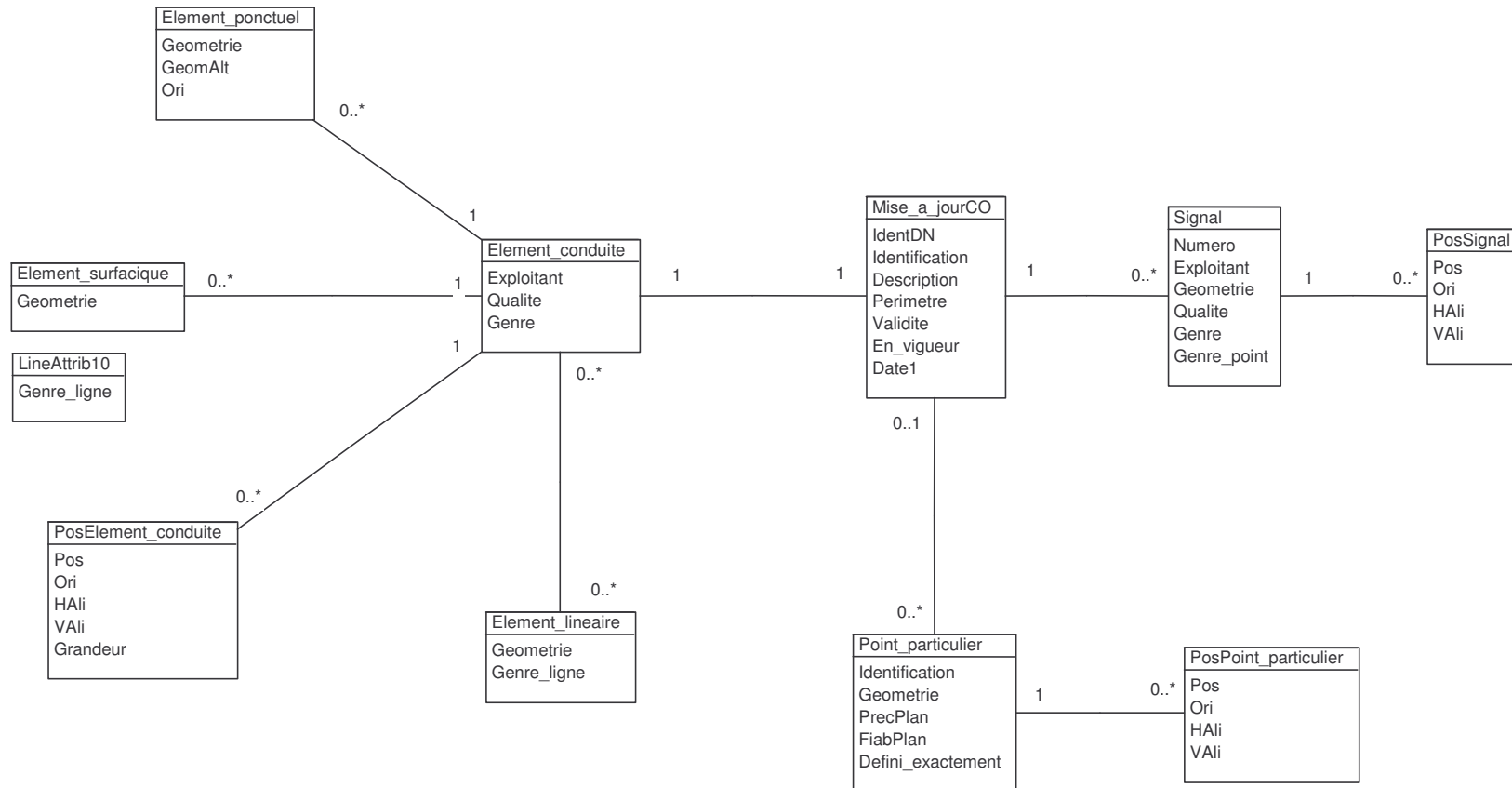

Domaines_numerotation

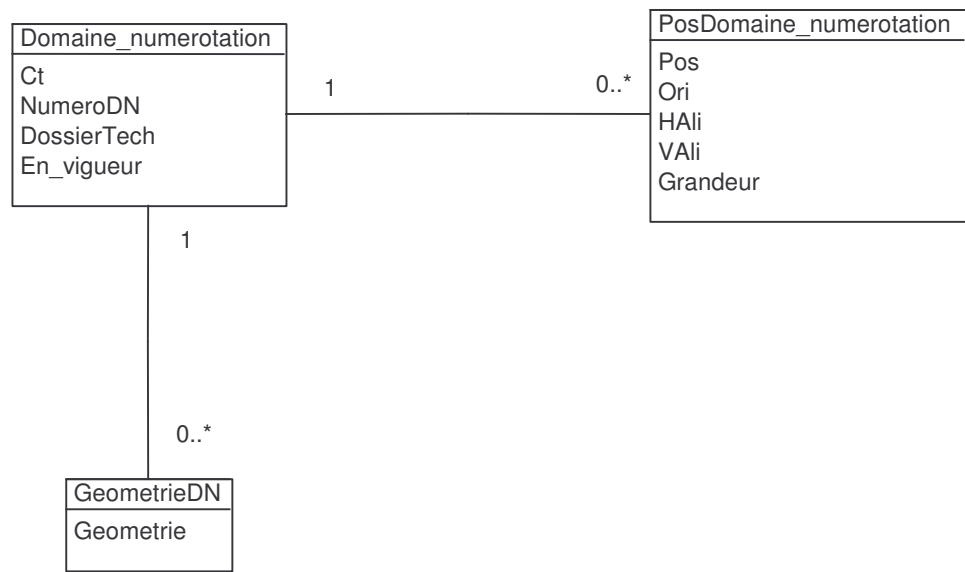

Limites_commune

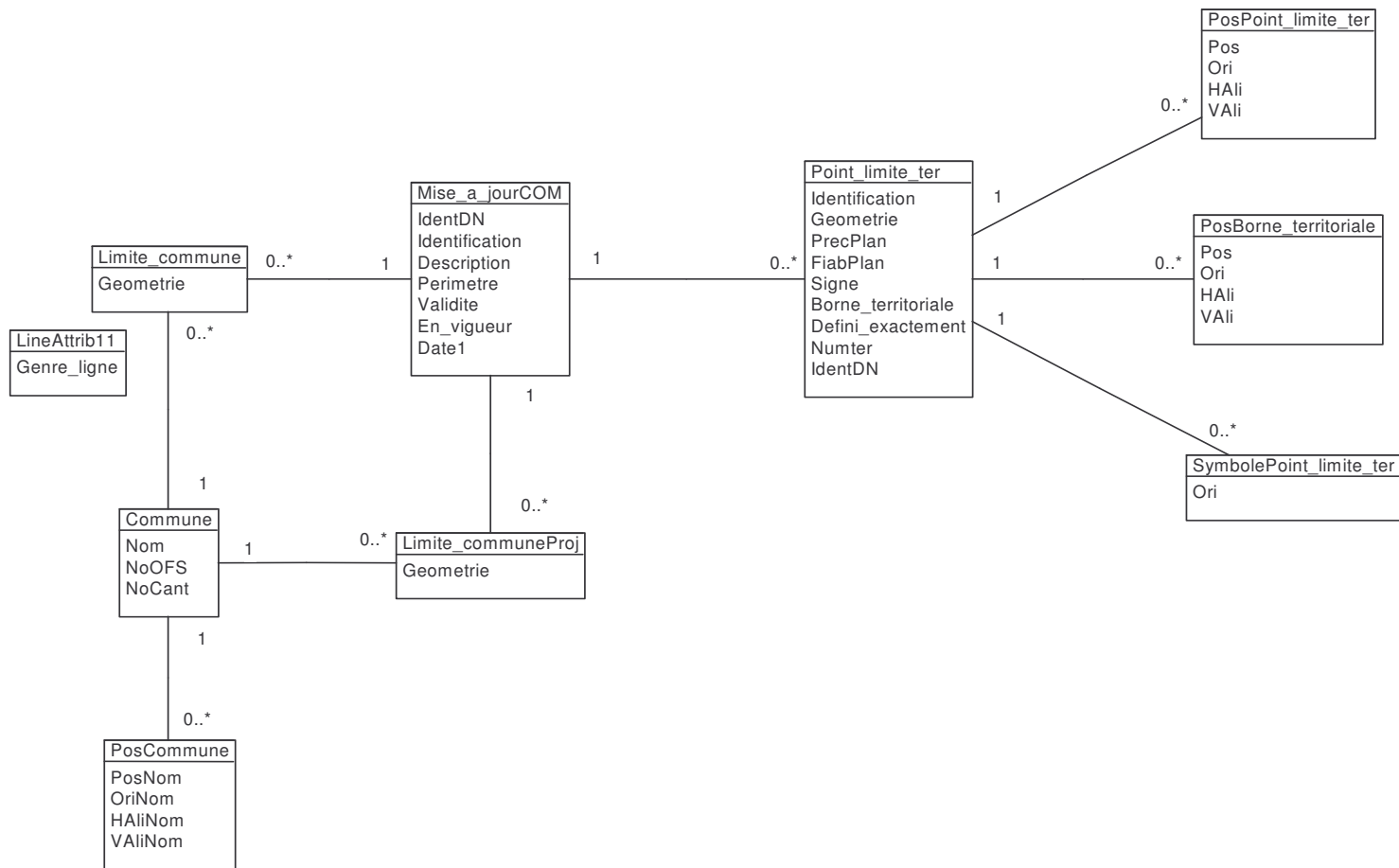

Limites_district

Partie_limite_district
Geometrie
Validite

Limites_nationales

Partie_limite_nationale
Geometrie
Validite

Limites_canton

Partie_limite_canton
Geometrie
Validite

Nomenclature

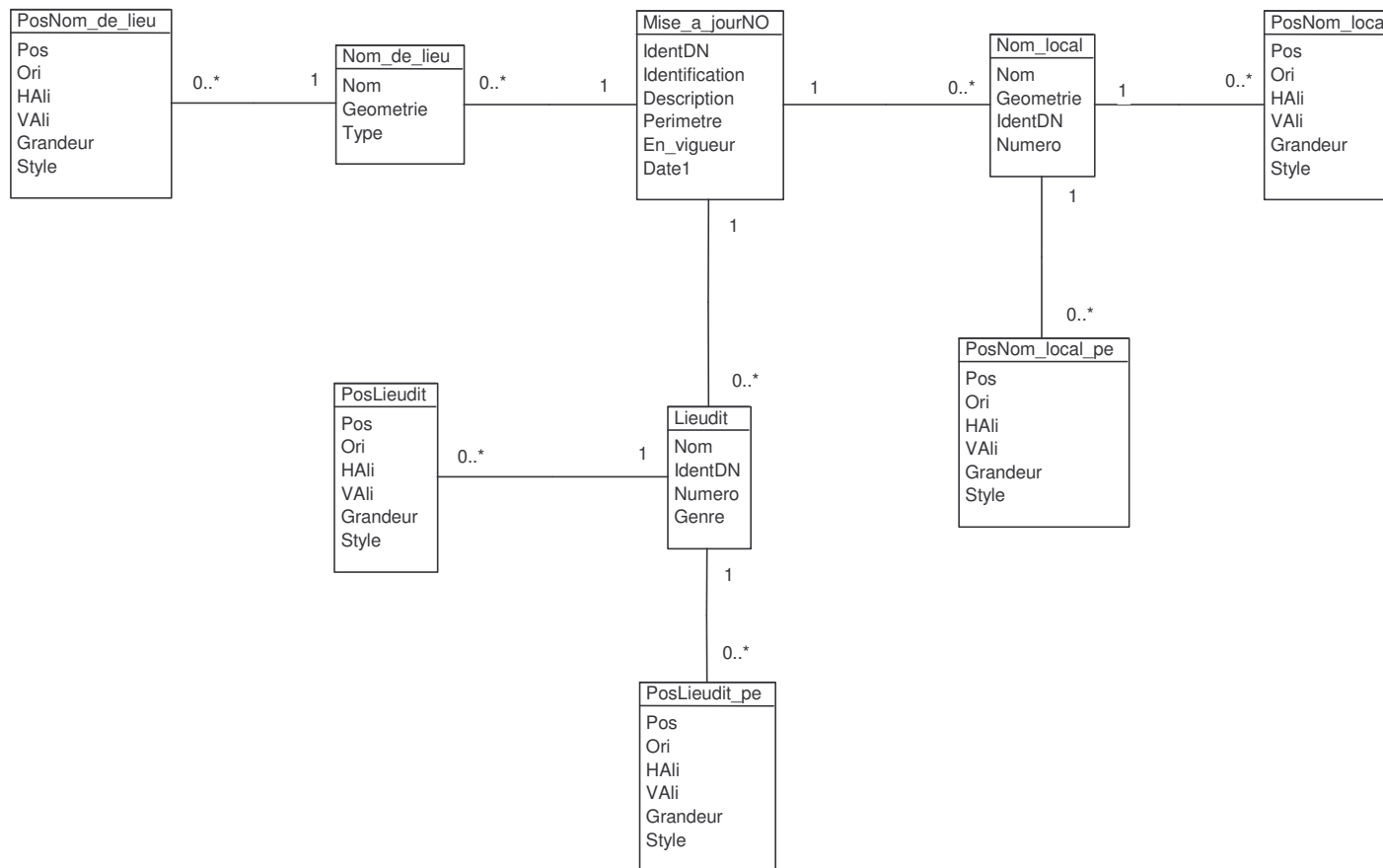

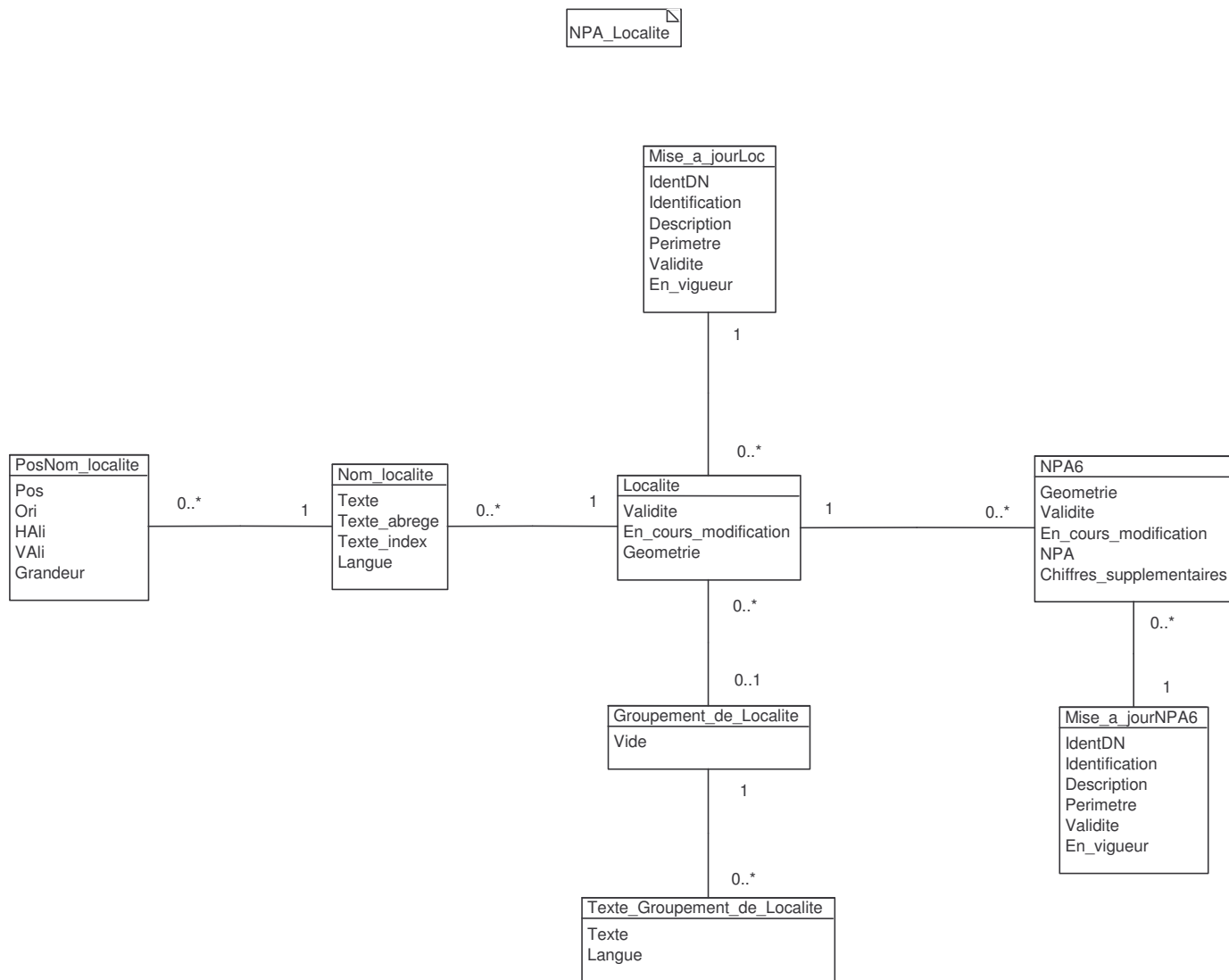

Objets_divers

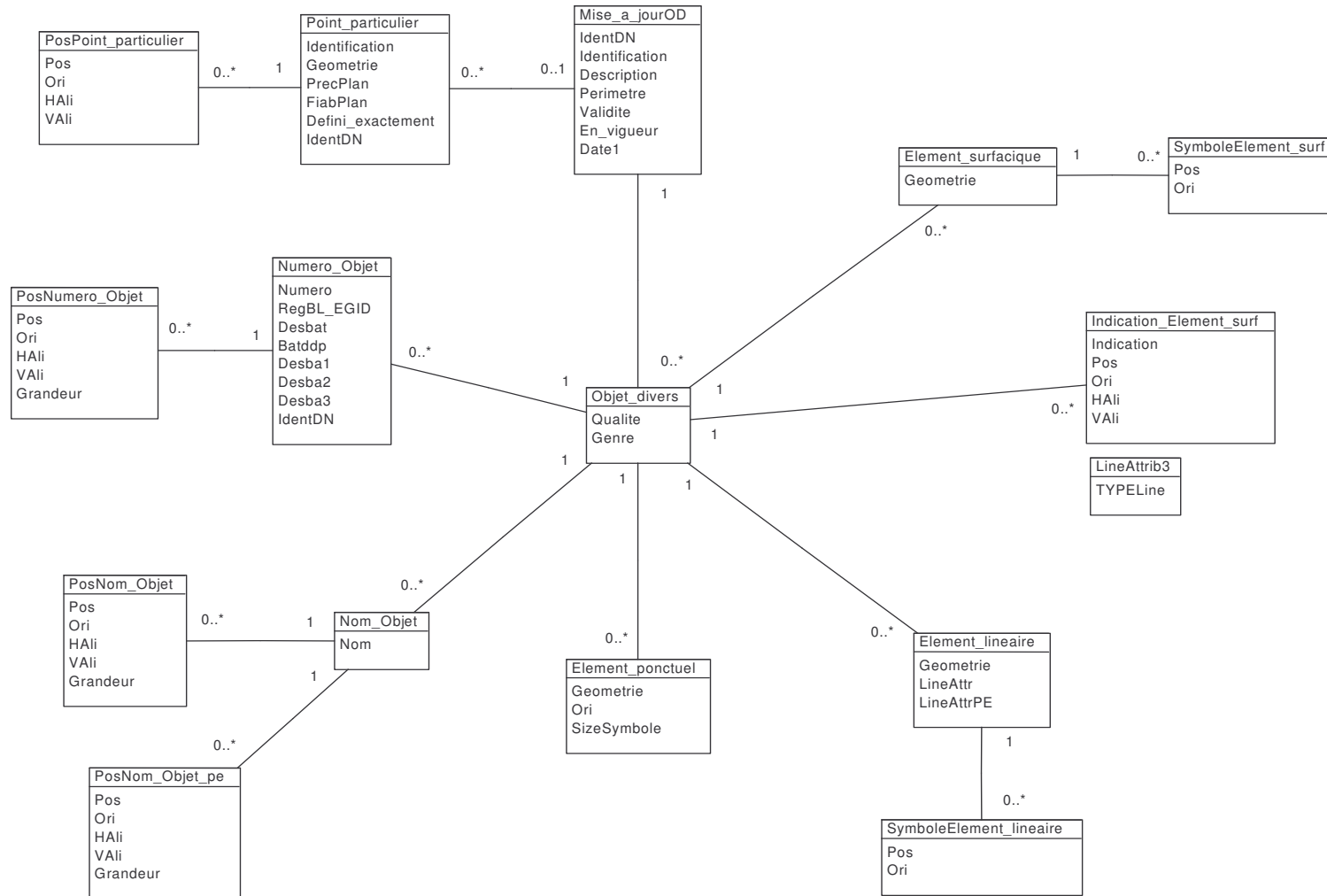

Points_fixesCategorie1

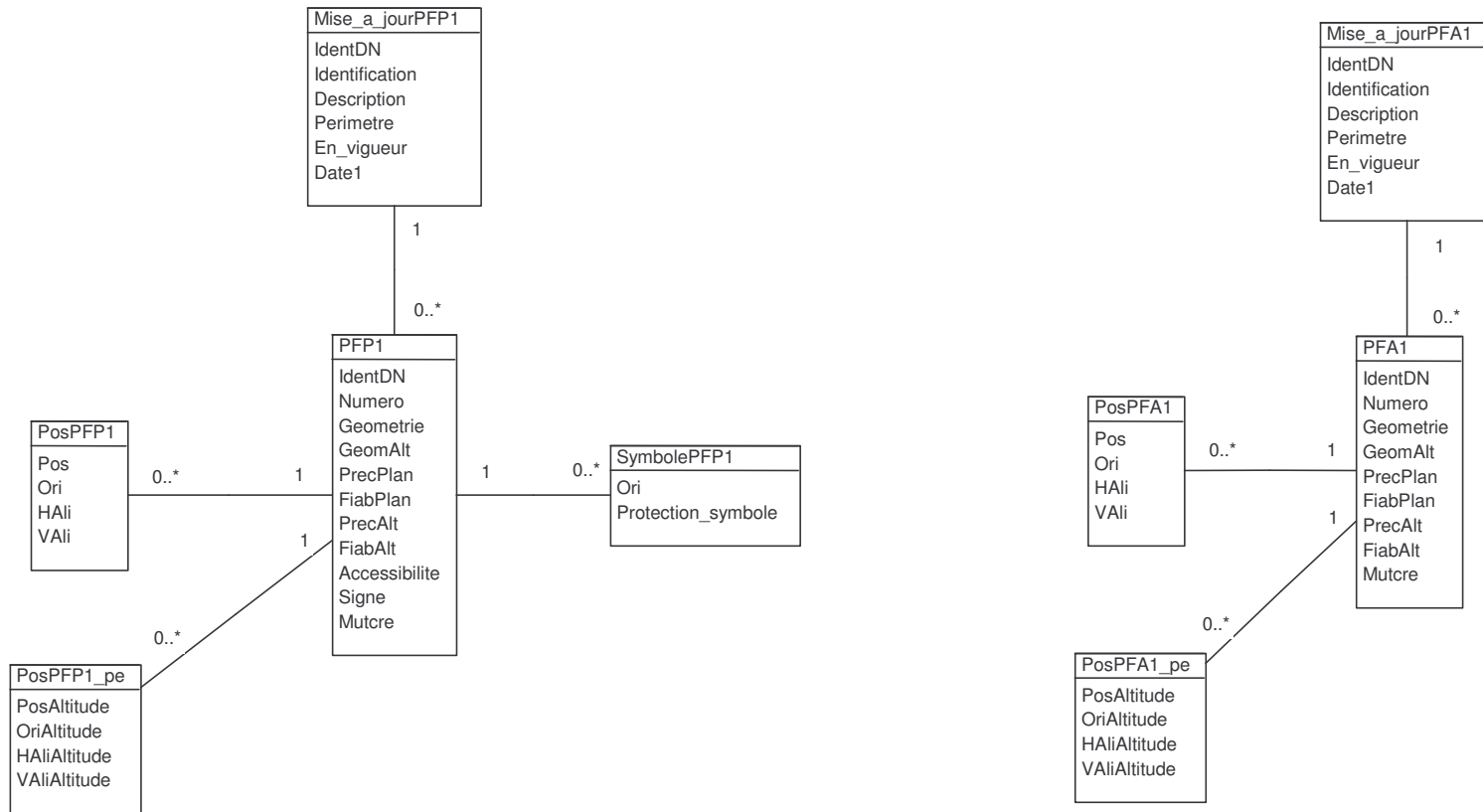

Points_fixesCategorie2

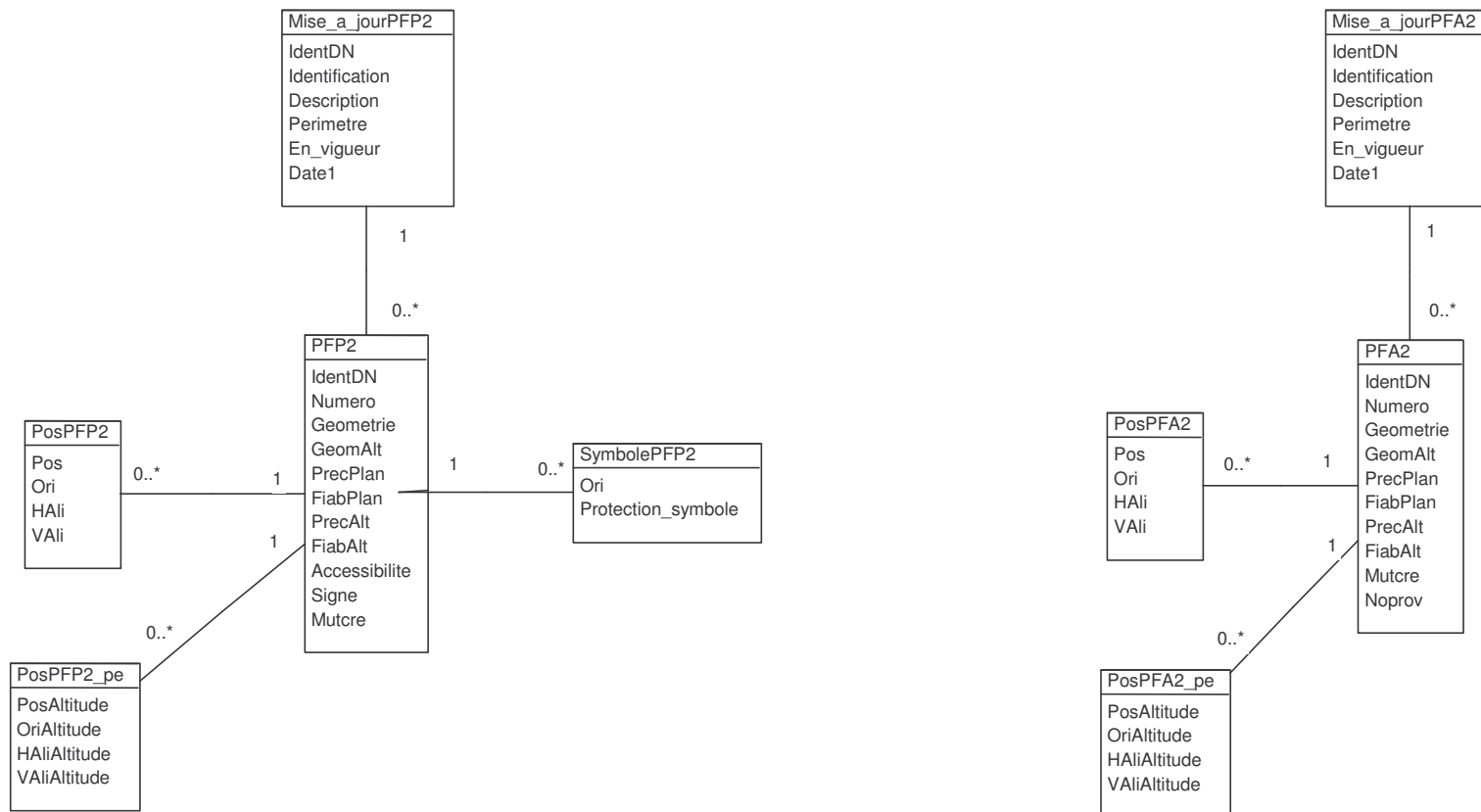

Points_fixesCategorie3

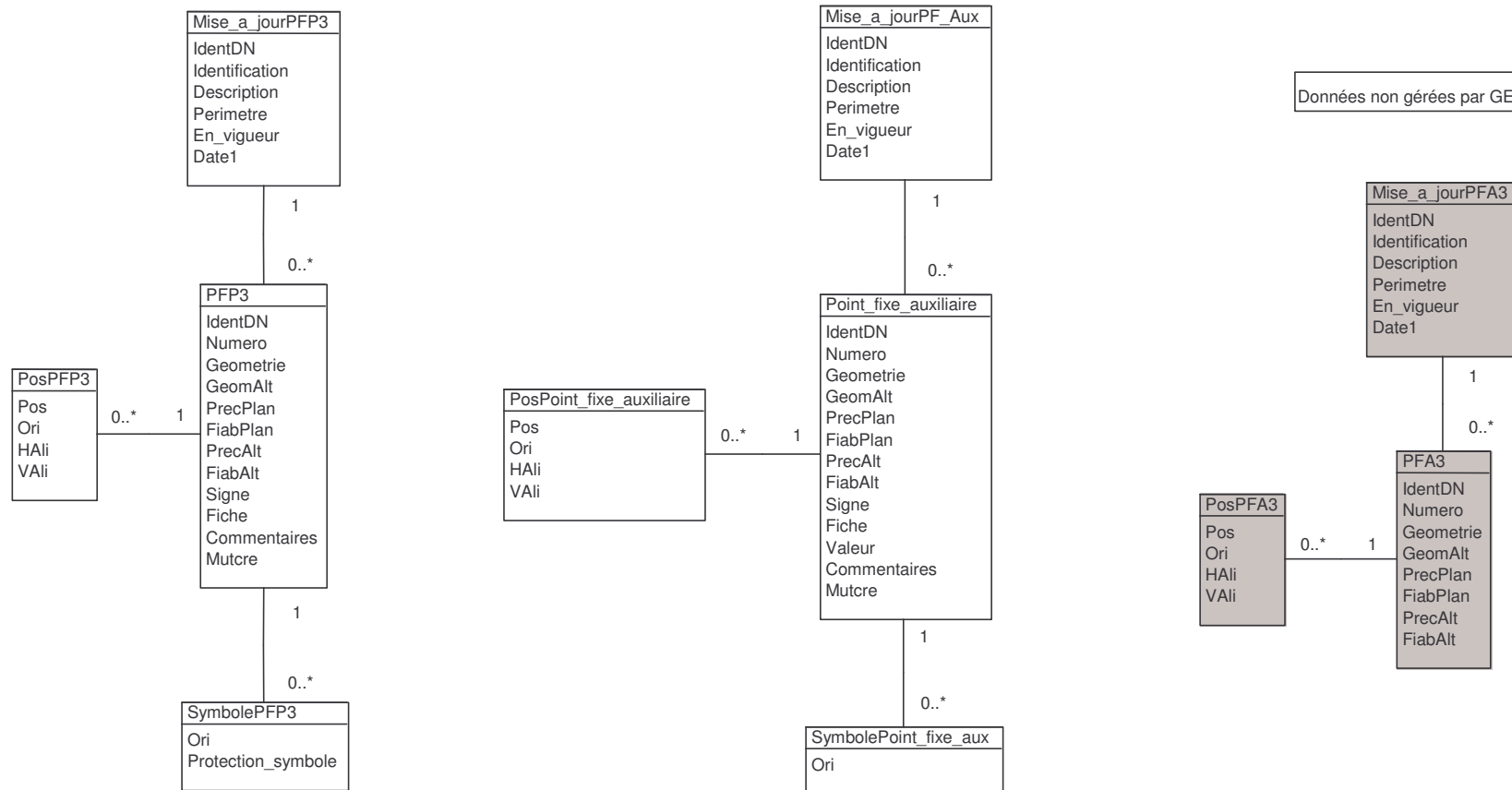

RepartitionNT

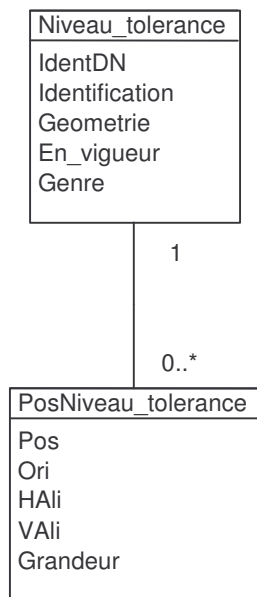

Repartitions_plans

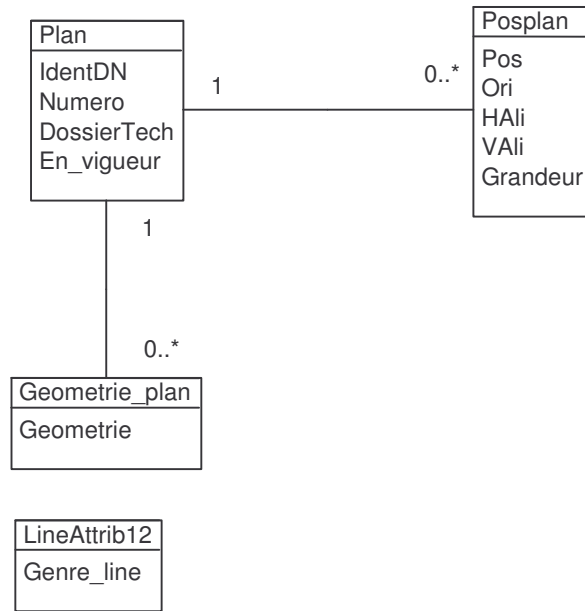

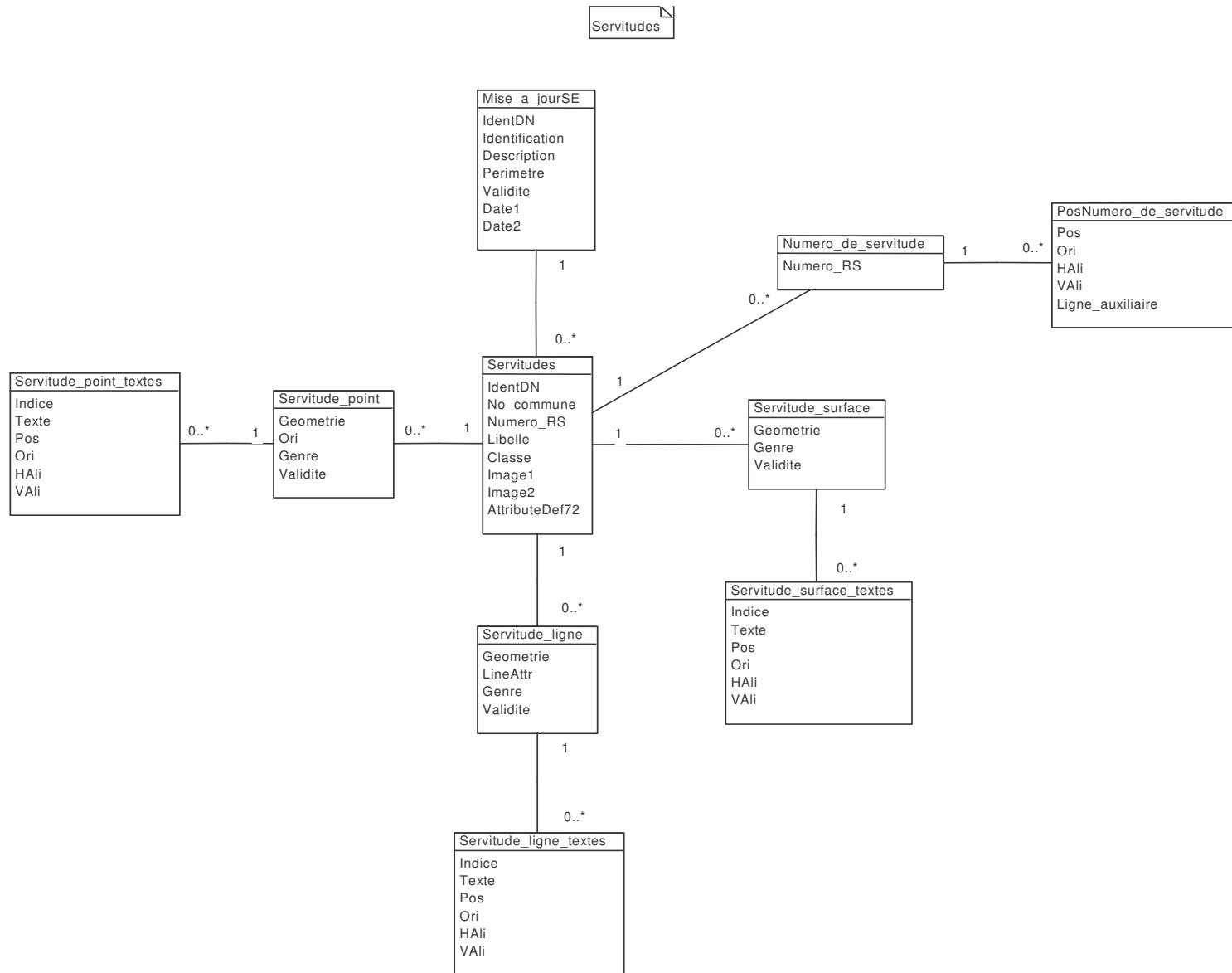

Zones_glissement

Glissement
IdentDN
Identification
Nom
Geometrie
En_vigueur

1

0..*

PosGlissement
Pos
Ori
HAl
VAl
Grandeur